

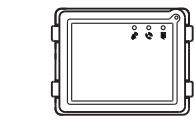

Module overview

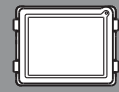

Audio module  
(Only for Welcome)

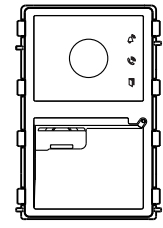

Audio/video module

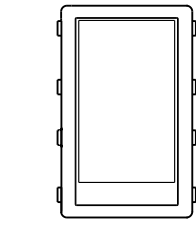

Touch 5 module  
(Only for Welcome IP)

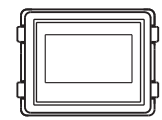

Display module

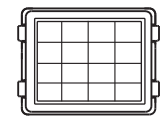

Keypad module

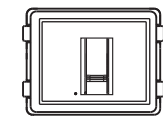

Fingerprint module

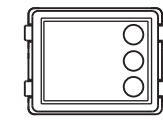

Round pushbutton  
module

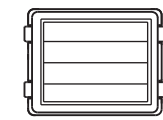

Bar pushbutton  
module

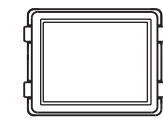

Information module

Cover frame (Unit: mm)

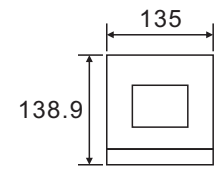

Cover frame 1/1  
(Only for Welcome)

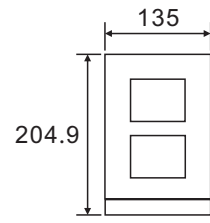

Cover frame 1/2  
(Only for Welcome)

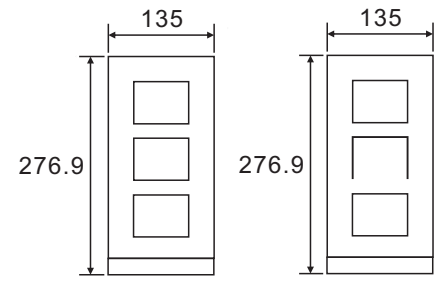

Cover frame 1x3

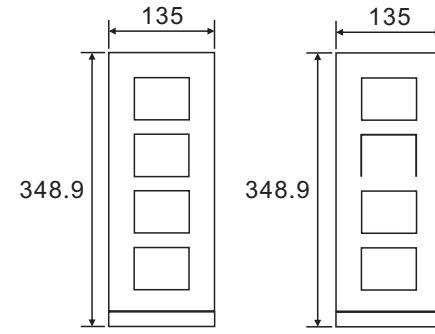

Cover frame 1x4

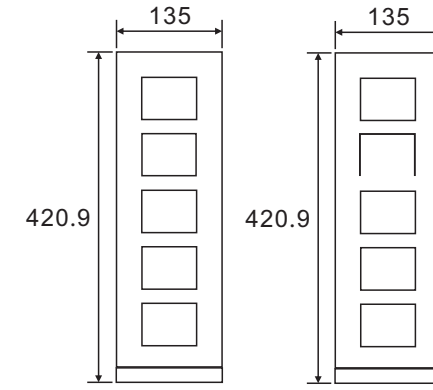

Cover frame 1x5

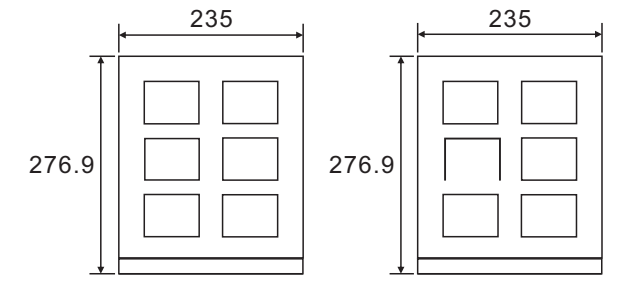

Cover frame 2x3

Surface-mounted box (Unit: mm)

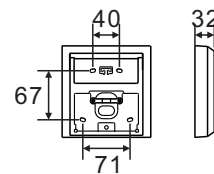
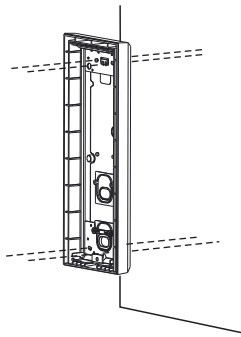

1x1

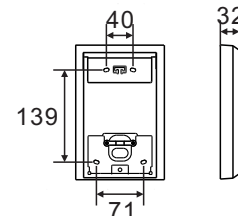

1x2

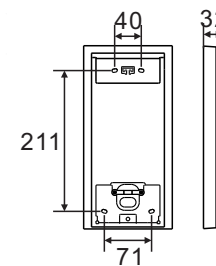

1x3

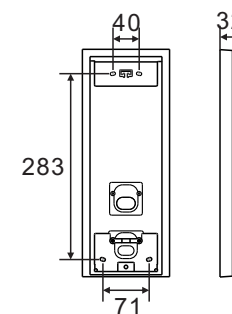

1x4

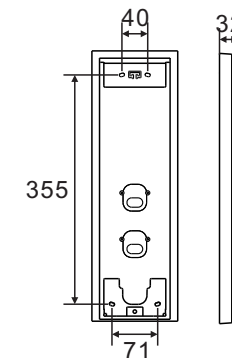

1x5

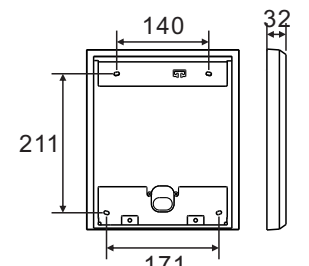

2x3

Hole size for flush-mounted box (Unit: mm)

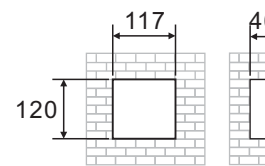
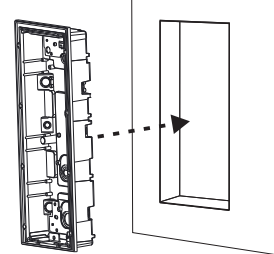

1x1

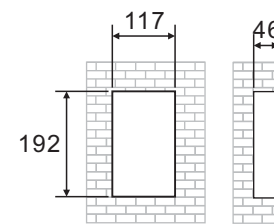

1x2

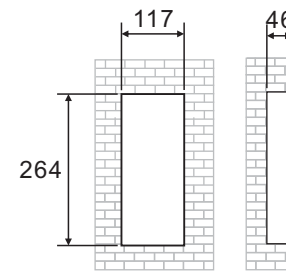

1x3

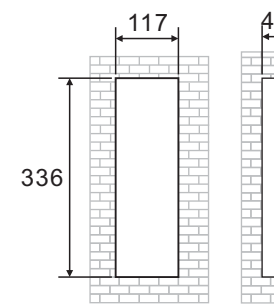

1x4

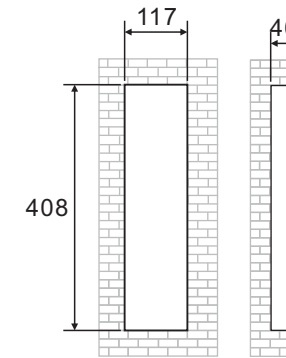

1x5

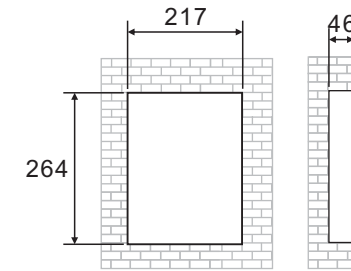

2x3

Hole size for pre-installation box (Unit: mm)

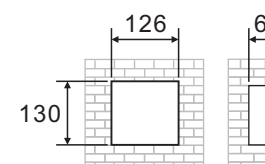
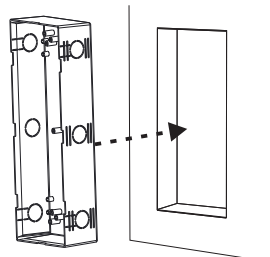

1x1

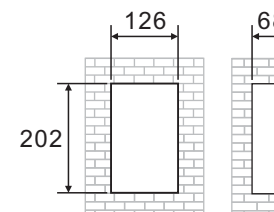

1x2

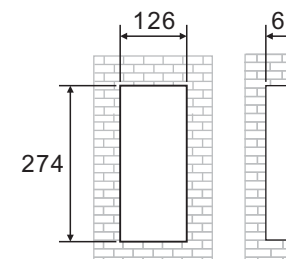

1x3

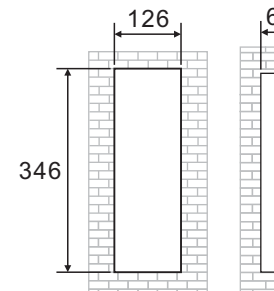

1x4

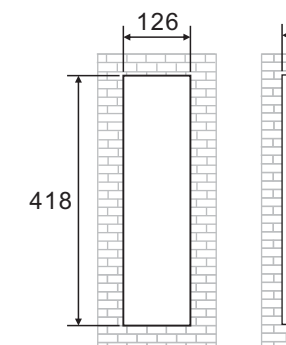

1x5

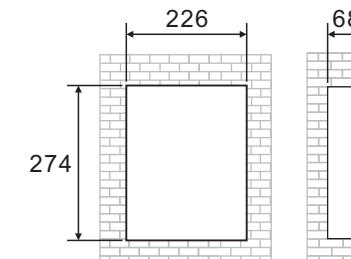

2x3



Preparation

Use gloves to protect yourself against cuts.

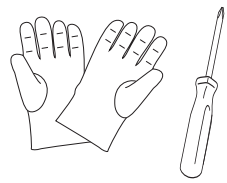

Modules mounting and wiring

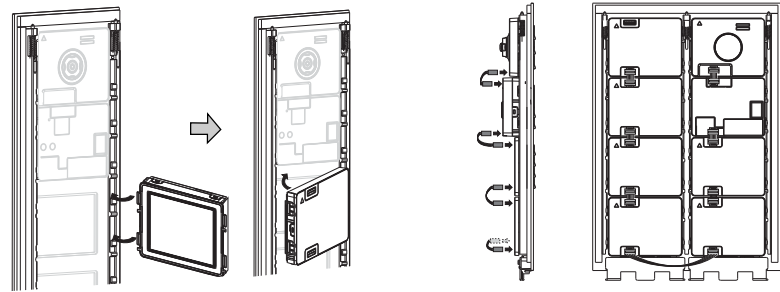

Adjust the camera view

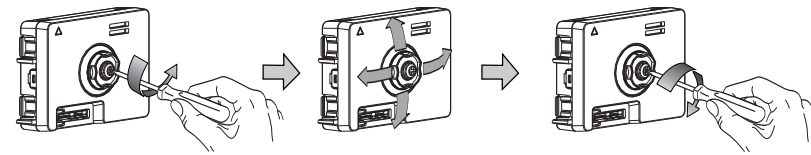

Installation height

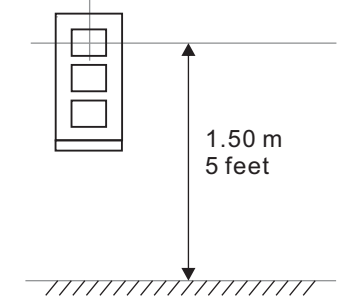

Surface-mounted installation

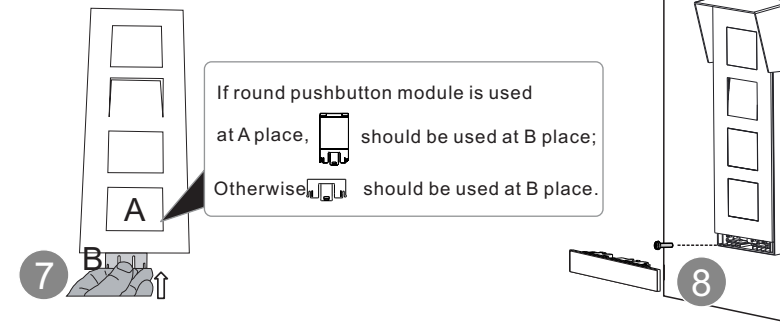
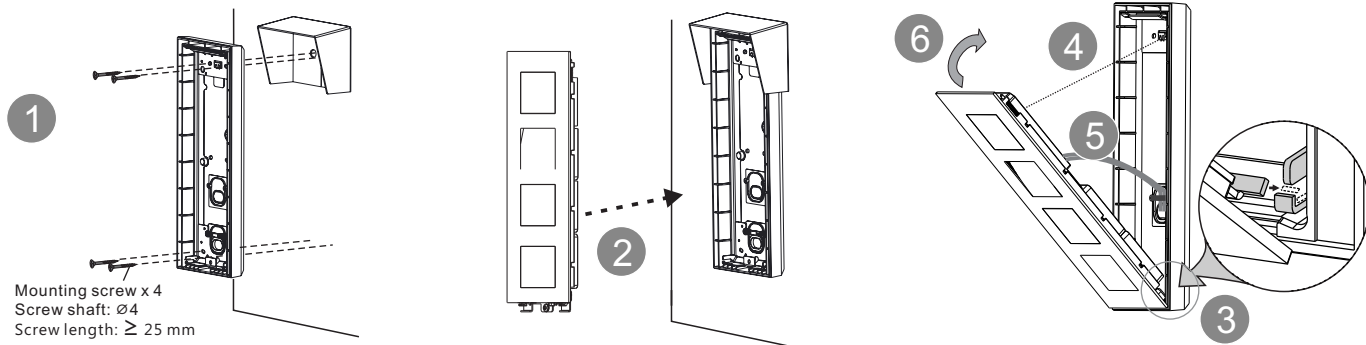

Flush-mounted without pre-installation box

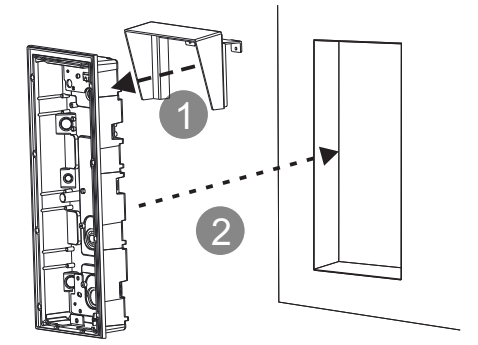

Flush-mounted with pre-installation box

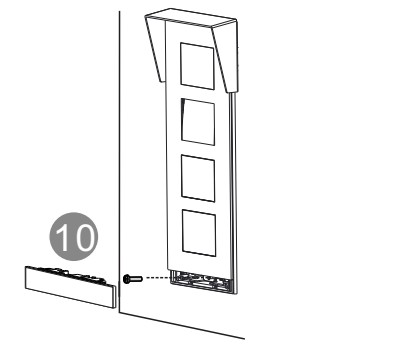
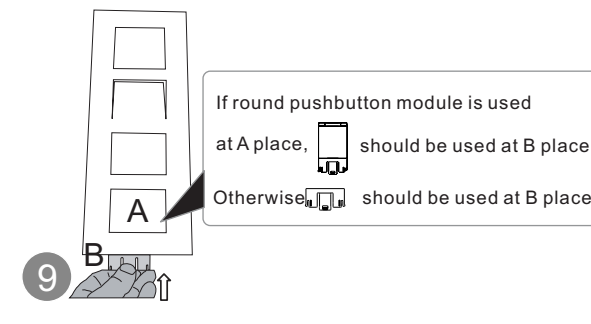
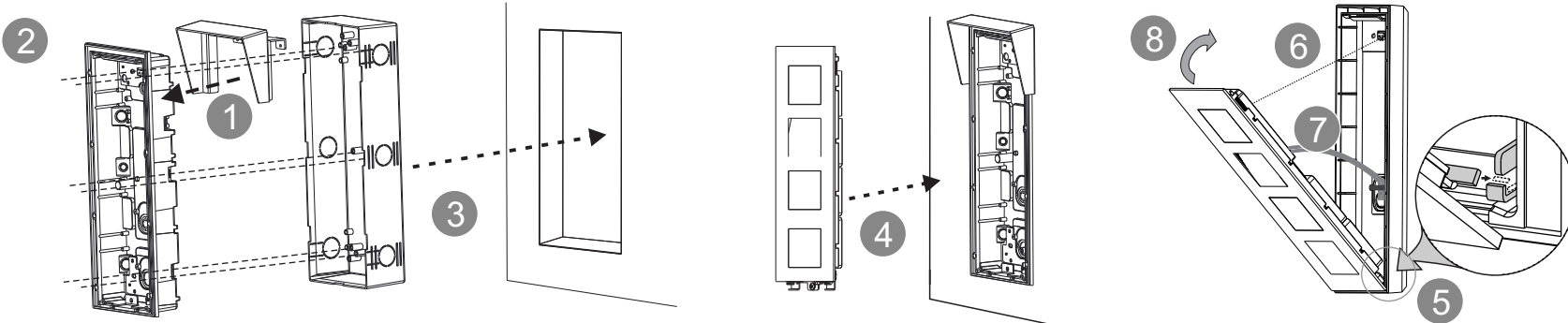

Cavity wall installation

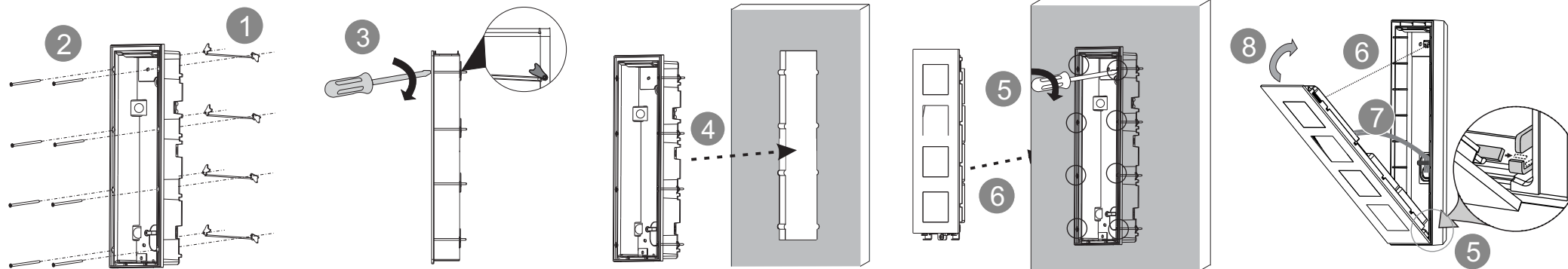

A and B is the same with surface mounted.

Dismantle the outdoor station from the wall

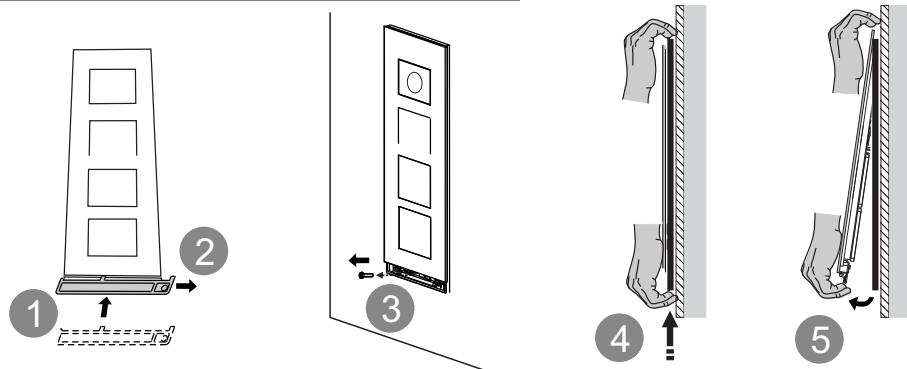

Dismantle the modules

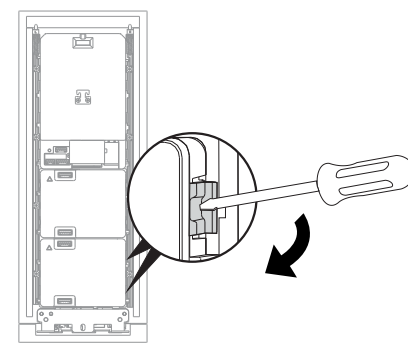

Dismantle the name label

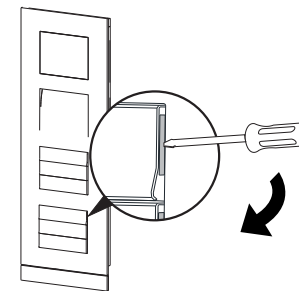

Replace the nameplate

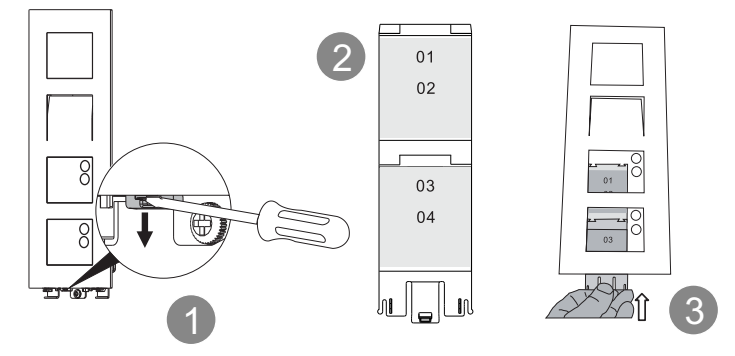



Multi-column wiring

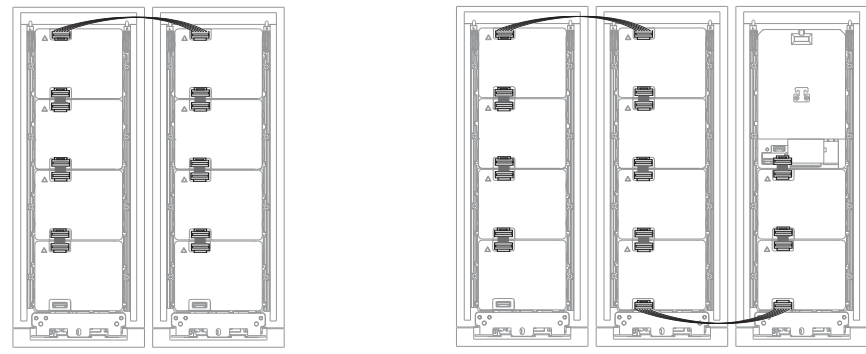

Multi-column without pre-installation box

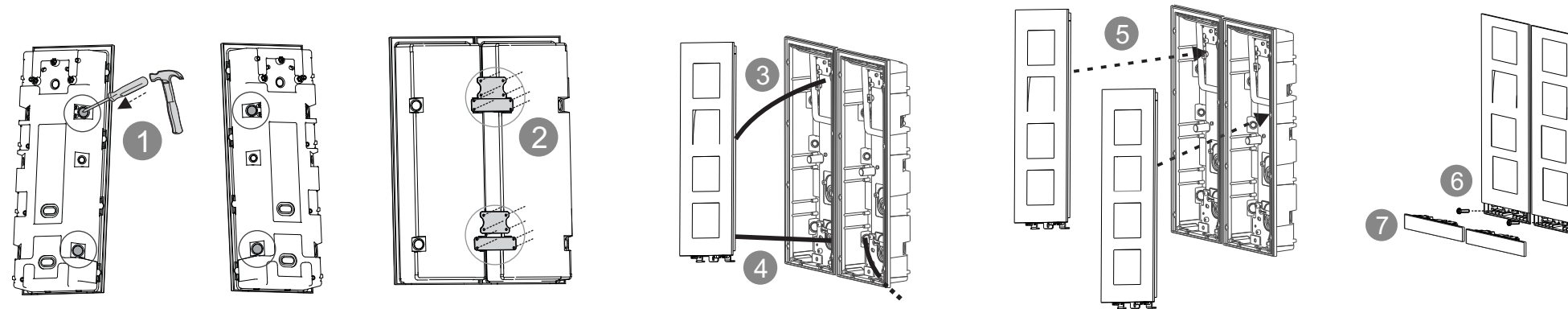

Multi-column with pre-installation box

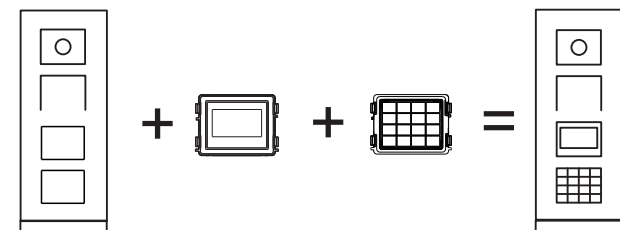
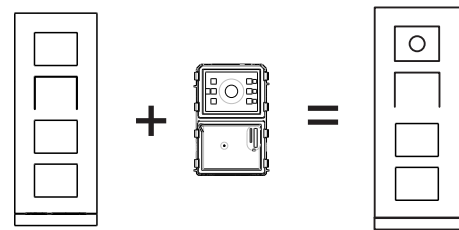
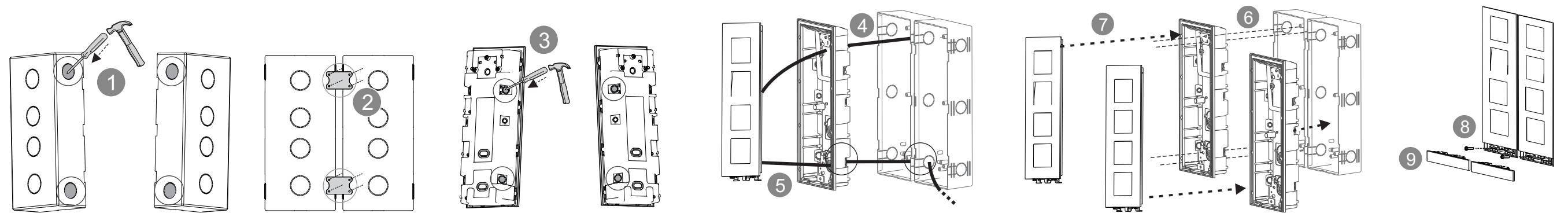

2 different round button modules can work together.

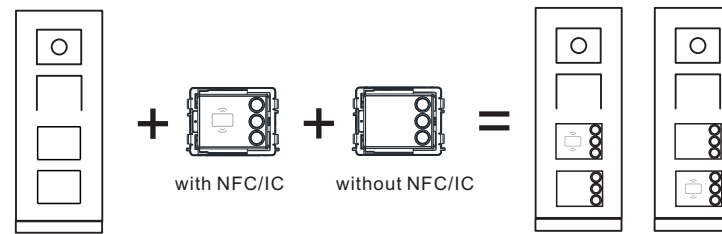

Round button module can be placed as above.

2 round button modules with NFC/IC can't work together.

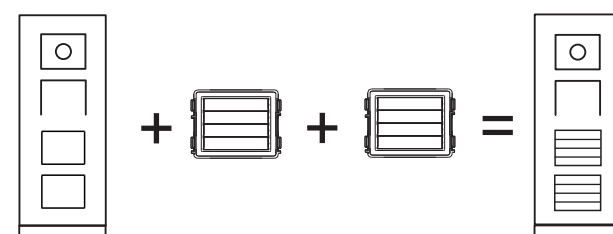
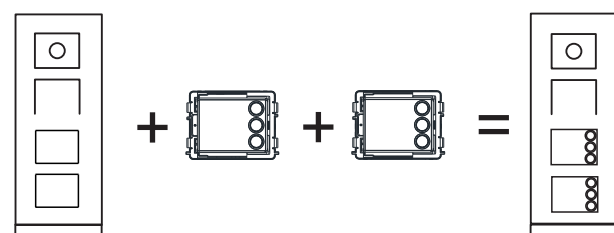
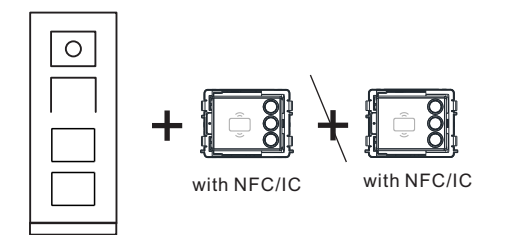

Round button module and bar button module can't work together.

